

# EB24 COUPLING WINDOW & DOOR SECTIONS

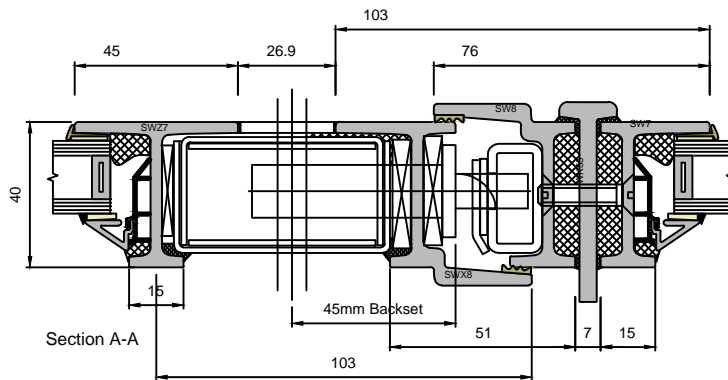
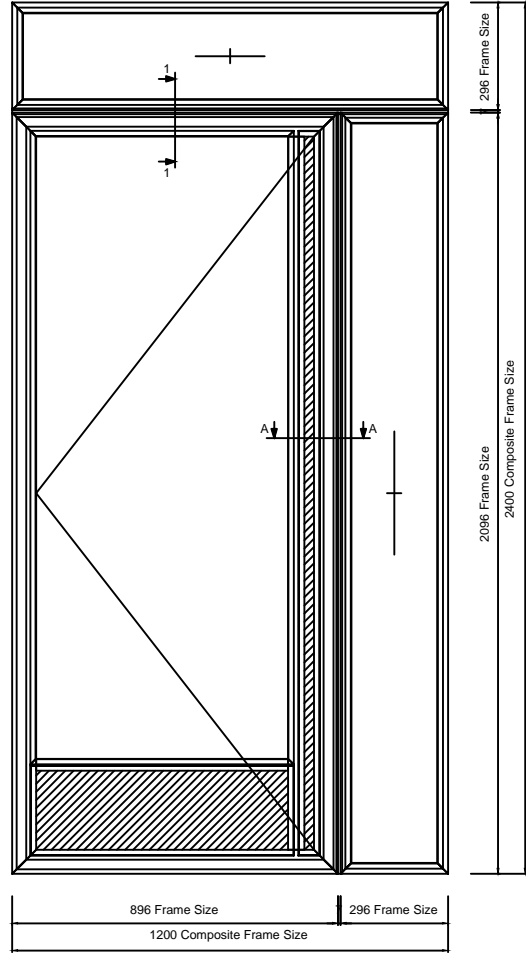
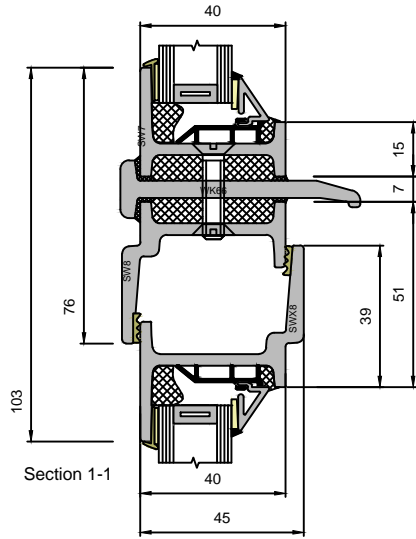

**CLEMENT**  
*creating light...beautifully*

Copyright Reserved 2024,  
Clement Windows Group Ltd  
This product is protected by the provisions of the Copyright, Design & Patents Act 1988

EMAIL: [info@clementwg.co.uk](mailto:info@clementwg.co.uk)  
WEBSITE: [www.clementwindows.co.uk](http://www.clementwindows.co.uk)

DETAILS SUBJECT TO CHANGE WITHOUT NOTICE

DATE: 13/09/2023

SCALE @ A4: 1:2 & 1:20

DRAWING TITLE:  
**EB24 COUPLING DETAILS**

CLIENT:

DRAWING No.

**EB213**

REVISION:

**A**